

Varenummer: 204040M16200A0U

Beskrivelse: E+G Justerfod
GN 40-40-M16-200-A0-U

Note: U Uden møtrik, sekskant i toppen, spændeflade i bunden

Mål

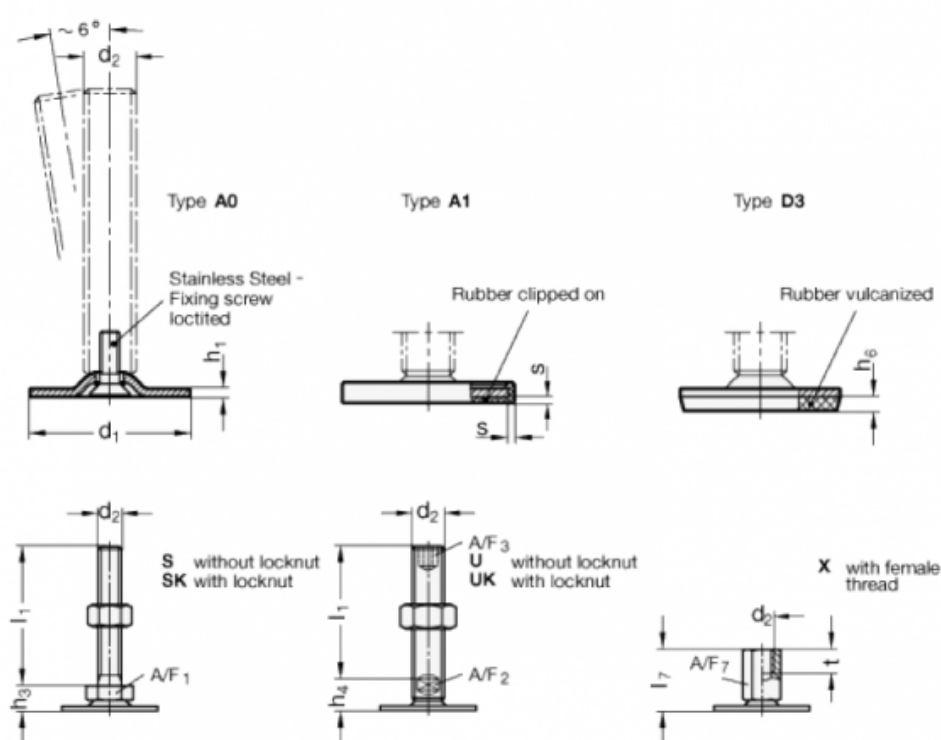

A/F2 = 12

A/F3 = 8

d1 = 40

d2 = M16

h1 = 2

h4 = 17

h6 =

l1 = 200

s =